

# AWESOME!



QUESTIONS? | Email us at  
**HOLLA@JAXXLIVING.COM**  
or call our friendly  
customer service staff  
at 1.866.384.2802

**JAXXX**<sup>®</sup>  
*(for the life casual)*



## ALON DAYBED FRAME SET-UP INSTRUCTIONS

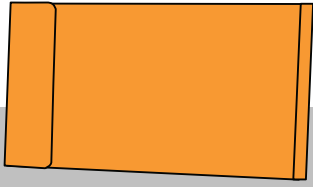

(1) plywood frame

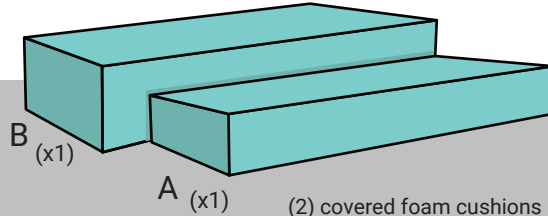

(2) covered foam cushions

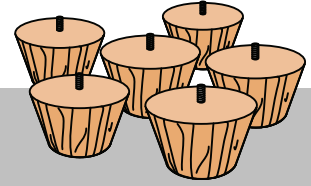

(6) maple feet

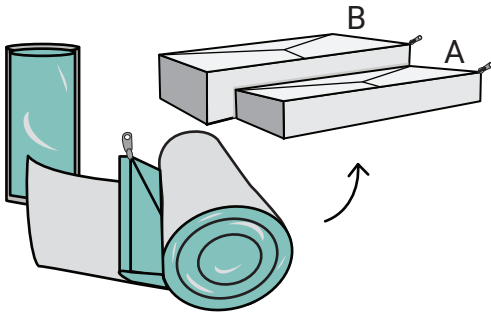

**Step 1** Unroll plastic film to release foam cushions.

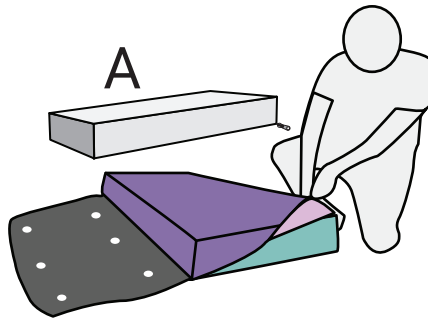

**Step 2** Dress (A) foam in cover with holes. Place foam zipper facing down. Leave unzipped.

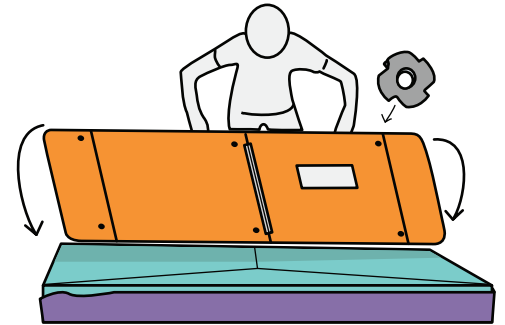

**Step 3** Flip and align plywood over the covered foam with the metal t-nuts and warning label facing down.

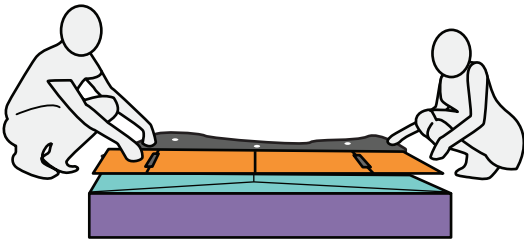

**Step 4** Place plywood on top of foam with its two metal hinges facing up.

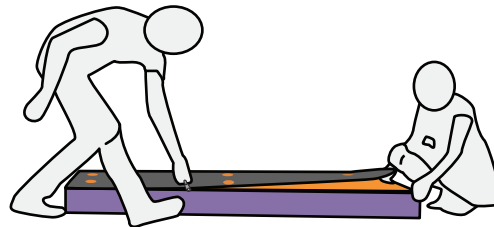

**Step 5** Zip cover to close.

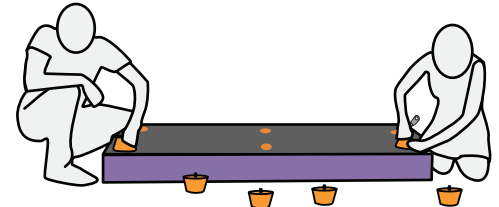

**Step 6** Screw feet into holes. Use rubber grips to tighten.

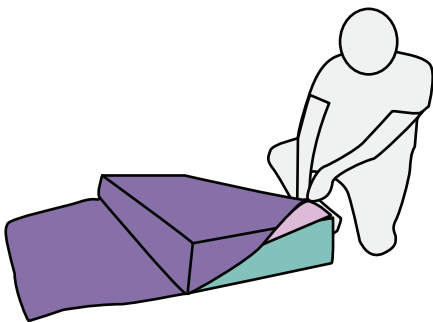

**Step 7** Dress taller (B) foam with zipper facing down. Zip to close.

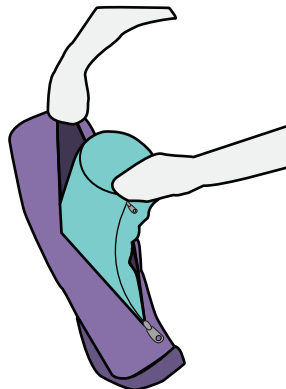

**Step 8** Bend foam bolster to fit into the slot of its cover. Zip to close.

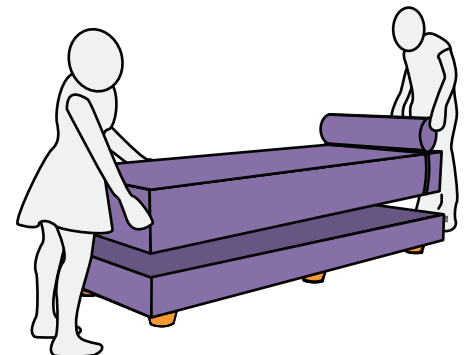

**Step 9** Place top cushion on top of bottom cushion with frame.